

WIRELESS OUTDOOR  
 DETECTOR  
**FTN-R-PT/  
 FTN-RAM-PT**

FTN-R-PT	Battery operated model with 2 PIRs
FTN-RAM-PT	FTN-R-PT with anti-masking

---

## FEATURES

---

- Narrow Angle Detection
- Detection Range Adjustability (2m / 5m)
- Intelligent AND logic
- Digital Anti-Masking (RAM model)
- Horizontal Adjustability
- Tamper Output
- Wall Tamper (option)

---

## CONTENTS



---

1	INTRODUCTION	
1-1	BEFORE INSTALLATION.....	2
1-2	PARTS IDENTIFICATION.....	3
1-3	DETECTION AREA.....	3
2	INSTALLATION	
2-1	MOUNTING.....	4
3	WALK TEST	
3-1	WALK TEST.....	6
4	DIP SWITCH SETTING	
4-1	WALK TEST MODE.....	7
4-2	BATTERY SAVING TIMER.....	7
4-3	ALARM & TROUBLE OUTPUT .....	7
4-4	LED.....	8
4-5	PIR SENSITIVITY.....	8
4-6	ANTI-MASKING.....	8
5	OTHERS	
5-1	LED LIGHT PATTERN.....	9
6	HOW TO REPLACE BATTERY.....	9
7	SPECIFICATIONS	
7-1	SPECIFICATIONS.....	10
7-2	DIMENSIONS.....	11

# 1



## INTRODUCTION

### 1-1 BEFORE INSTALLATION

 <b>Warning</b>	Failure to follow the instructions provided with this indication and improper handling may cause death or serious injury.
 <b>Caution</b>	Failure to follow the instructions provided with this indication and improper handling may cause injury and/or property damage.

The check  mark indicates recommendation.

The nix  sign indicates prohibition.

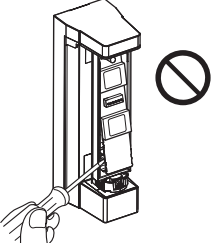
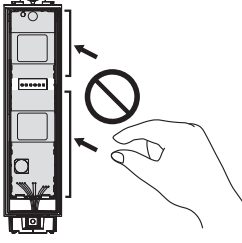
 <b>Warning</b>	 <b>Caution</b>
Do not remove the PCB. 	Do not touch the PCB except for the DIP switch. 

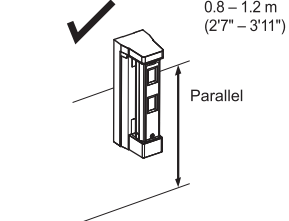
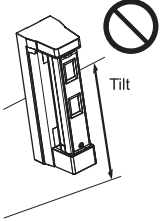
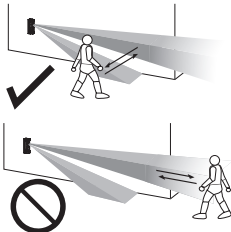
<b>Mounting height.</b> 	<b>Keep the detector parallel to the ground.</b> 	<b>Consider the direction a person is approaching from, as well as the detection area.</b> 
---	--	--

Install the detector in a place where it is free from false alarm factors. For example:

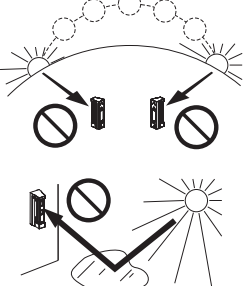
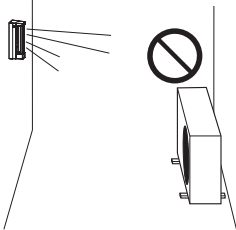
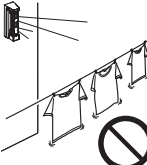
<ul style="list-style-type: none"> <li>• Sunlight and reflection</li> </ul> 	<ul style="list-style-type: none"> <li>• Heat source</li> </ul> 	<ul style="list-style-type: none"> <li>• Objects moving in the wind</li> </ul> 
---	---	--

## 1-2 PARTS IDENTIFICATION

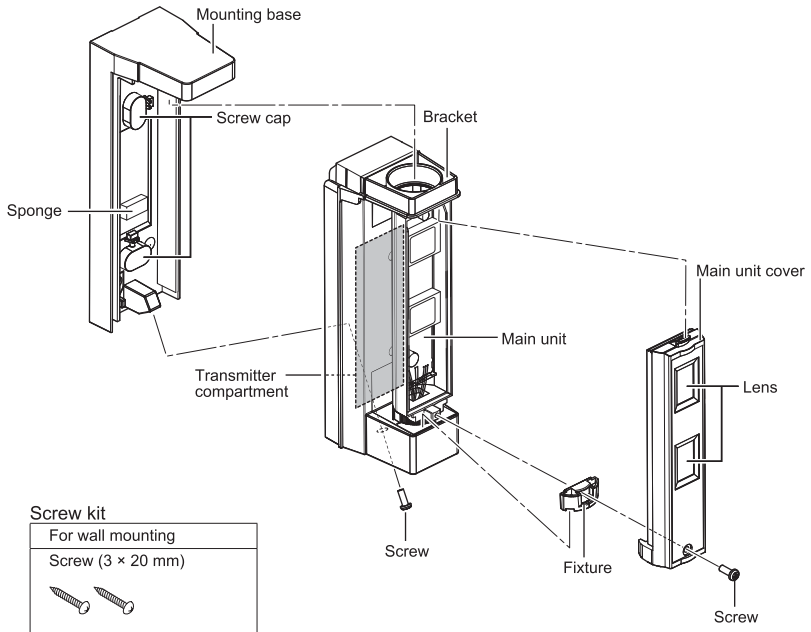

## 1-3 DETECTION AREA

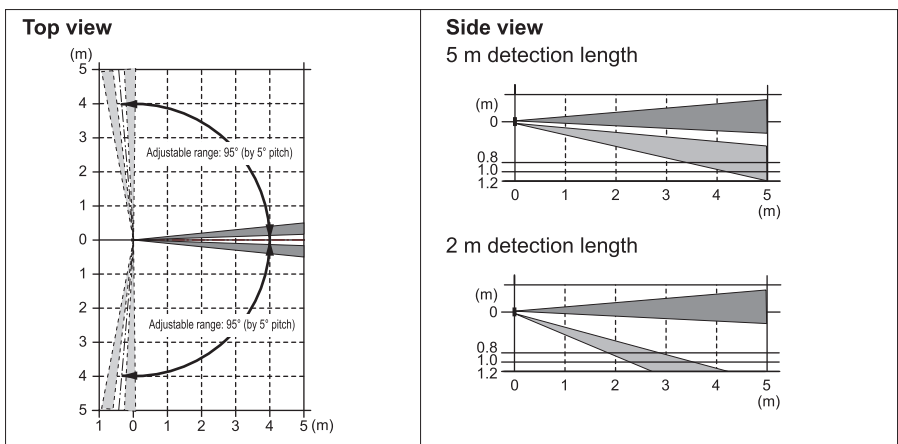

# 2

## INSTALLATION

### 2-1 MOUNTING

#### 1 Remove the mounting base.

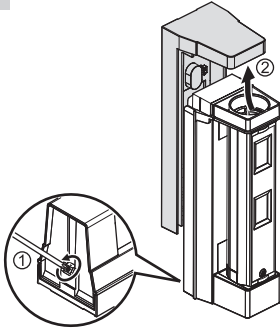

#### 2 Open the knockout.

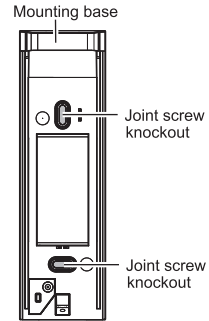

#### 3 Mount the mounting base on the wall.

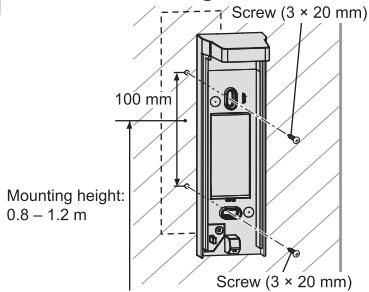

**Note>>**

- Transmitter needs to be enrolled to receiver before installing the detector.

#### 4 Attach the bracket and main section.

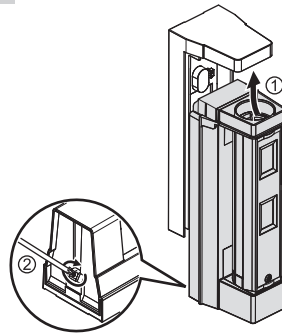

#### 5 Open the main unit cover

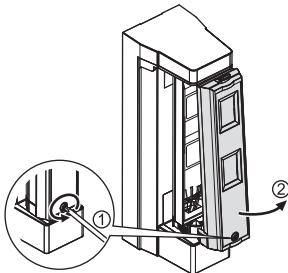

**Note>>**

- Be sure to set the screw cap after installing the mounting base.

## 6 Determine the horizontal detection angle and attach the fixture.

### Note>>

- To make adjustments, remove the fixture.

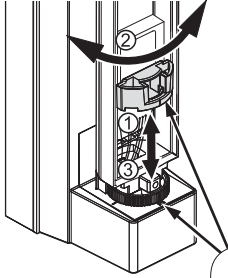

### Note>>

- Check that the fixture and bracket engage correctly.



### Notes>>

Align the detection area parallel to the wall to reduce interference with the wall.

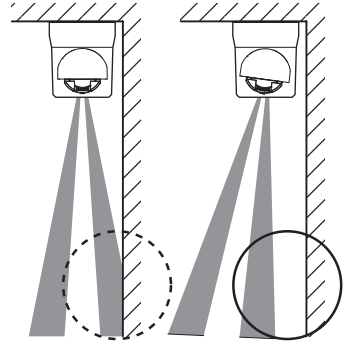

- When the unit is mounted on the wall to look transversely, choose the guide-mark engraved.

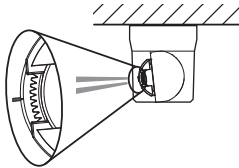

- When the unit is mounted on the corner to look ahead along the wall, choose the guide-mark located on the opposite side of the wall.

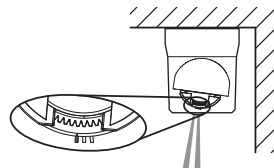

## 7 Determine the detection length. (2 m or 5 m)

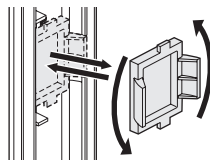
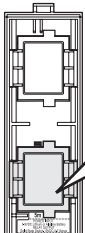

If 2 m is required, rotate the lower lens 180 degrees.

### Note>>

- Do not remove the upper lens.

### 5 m detection length (Factory default)

Side view

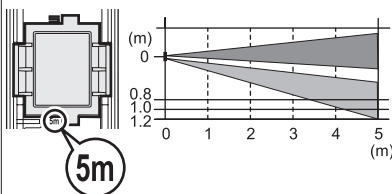

### 2 m detection length

Side view

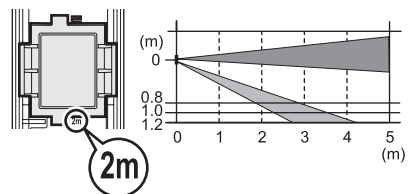

**8 Attach the fixture.**

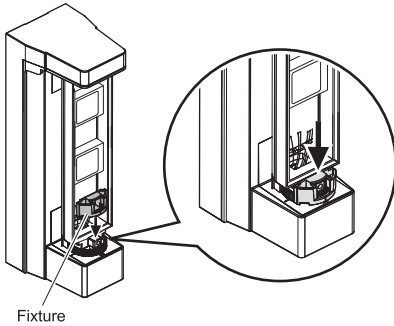

Fixture

**9 Attach the main unit cover.**

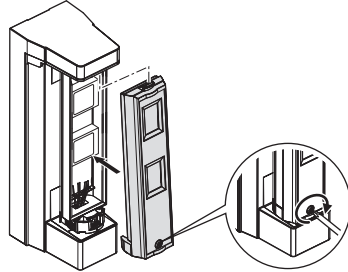

**Note>>**

- To prepare for walk test, check that DIPswitch 1 (WALKTEST MODE) is set to "ON (TEST)" before attaching main unit cover.

**10 Perform walk test.**  
For details, refer to 3-1.

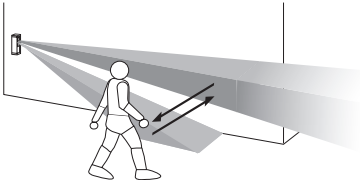

**11 After walk test is complete, set DIP switch 1 (WALK TEST MODE) from "ON" to "OFF".**

**Note>>**

- The battery life will be shortened unless the DIP switch 1 is set to "OFF".

## 3 WALK TEST

### 3-1 WALK TEST

**1 Set the DIP switch 1 (WALK TEST MODE) to "ON (TEST)".**

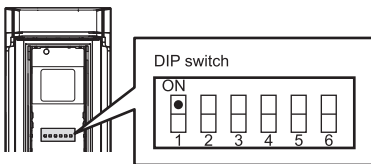

**Note>>**

- The switch is set to "ON (TEST)" by factory default.

**2 Check that LED lights for 2 seconds when the intended object is detected.**

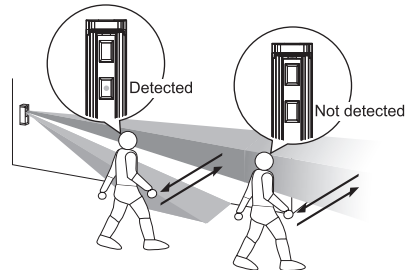

**3 Set the DIP switch 1 (WALK TEST MODE) to “OFF (NORM)”.**

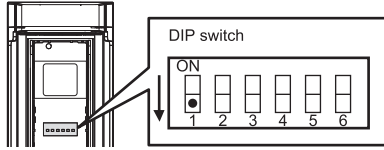

**Notes>>**

- The battery life will be shortened unless the DIP switch 1 is set to “OFF”.
- To use the LED in normal operating condition, set the DIP switch 4 to “ON”.

**4 DIP SWITCH SETTING**

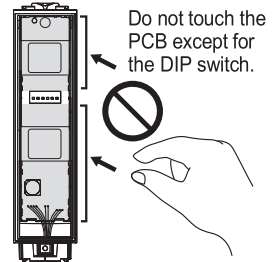
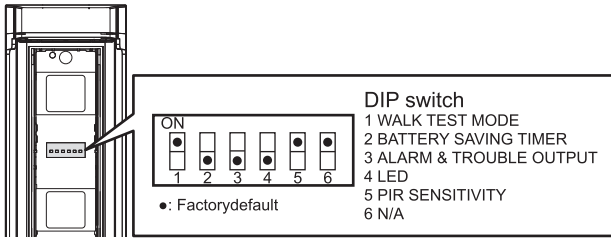

**4-1 WALK TEST MODE**

DIP switch 1

FTN-R-PT  
FTN-RAM-PT

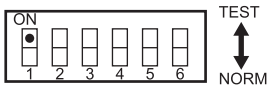

Position	Function
TEST (Factory default)	<ul style="list-style-type: none"> <li>• The LED lights irrespective of the DIP switch 4 (LED) setting.</li> <li>• The DIP switch 2 (BATTERY SAVING TIMER) setting is inactive.</li> </ul>
NORM	<ul style="list-style-type: none"> <li>• The LED lights depending on the DIP switch 4 (LED) setting.</li> <li>• The DIP switch 2 (BATTERY SAVING TIMER) setting is active.</li> </ul>

**4-2 BATTERY SAVING TIMER**

DIP switch 2

FTN-R-PT  
FTN-RAM-PT

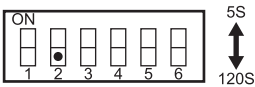

**Note>>**

- The detector will not generate alarms at intervals shorter than the specified time.

Position	Function
5S	5 sec.
120S (Factory default)	120 sec.

**4-3 ALARM & TROUBLE OUTPUT**

DIP switch 3

FTN-R-PT  
FTN-RAM-PT

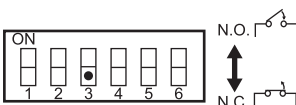

Position	Function
N.O.	N.O. output
N.C. (Factory default)	N.C. output

#### 4-4 LED

DIP switch 4

FTN-R-PT  
FTN-RAM-PT

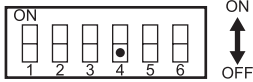

Position	Function
ON	LED ON
OFF (Factory default)	LED OFF <b>Note&gt;&gt;</b> • If the LED lights, check the DIP switch 1 (WALKTEST MODE) setting.

#### 4-5 PIR SENSITIVITY

DIP switch 5

FTN-R-PT  
FTN-RAM-PT

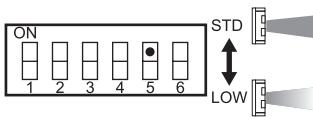

Position	Function
STD (Factory default)	Normal sensitivity
LOW	Low sensitivity

#### 4-6 ANTI-MASKING

DIP switch 6

FTN-R-PT  
FTN-RAM-PT

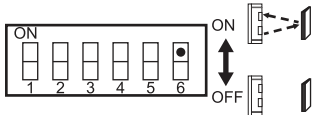

Position	Function
ON (Factory default)	ANTI-MASKING ON
OFF	ANTI-MASKING OFF

#### -ANTI-MASKING function

When masking condition continues more than 3 minutes, TROUBLE will be generated.  
TROUBLE is generated after 20 seconds under the anti-masking test mode.

Teaching mode starts when both the separate box cover and the main unit cover are attached.  
Please be careful not to leave any object within 1 m from the unit.

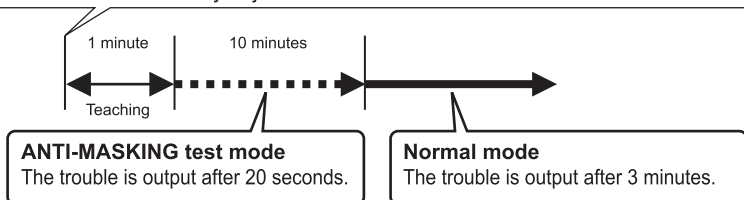



## 5 OTHERS

### 5-1 LED LIGHT PATTERN

The following explains the LED light pattern.

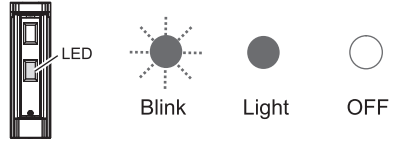

Detector condition	LED indicator
Warm-up <b>Note&gt;&gt;</b> • The LED blinks even if the DIP switch 4 (LED) is set to "OFF".	 Blinks for approx. 120 seconds.
Alarm	 Lights for 2 seconds.
Masking detection (FTN-RAM-PT only)	 Blinks 3 times and then repeats.

## 6 HOW TO REPLACE BATTERY

- 1 Remove the bracket and main section.

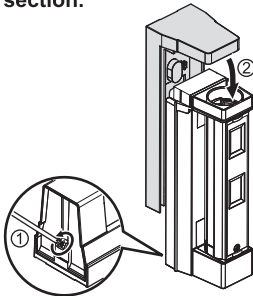

- 2 Replace the battery.

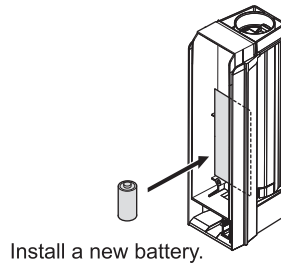

- 3 Attach the bracket and main section.

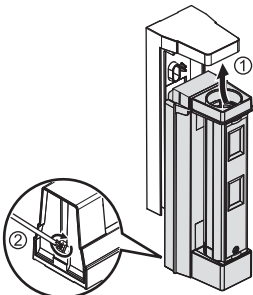

# 7

## SPECIFICATIONS

### 7-1 SPECIFICATIONS

Model	FTN-R-PT	FTN-RAM-PT
Detection method	Passive infrared	
PIR coverage	5 × 1 m (16'5" × 3'3")	
Detection length limit	2 m, 5 m (6'7", 16'5")	
Detectable speed	0.3 – 1.5 m/s (1' – 4'11"/s)	
Sensitivity	2.0°C (at 0.6 m/s) (3.6°F (at 2'/s))	
Operation voltage	2.5 – 10 V DC	
Power input	3 – 9 V DC (Lithium or Alkaline Battery)	
Current draw	9 µA standby / 3 mA max. at 3 V DC	10 µA standby / 3 mA max. at 3 V DC
Alarm period	2.0 ±1.0 sec.	
Warm-up period	Approx. 120 sec. (LED blinks)	
Alarm output	N.C./N.O. Selectable-Solid State Switch 10 V DC 0.01 A (max.)	
Trouble output	N.C./N.O. Selectable-Solid State Switch 10 V DC 0.01 A (max.)	
LED indicator	Enable: During DIP switch 1 (WALK TEST MODE) or DIP switch 4 (LED) ON Disable: During normal operation Light/Blink: Warm-up, alarm, masking detection (FTN-RAM-PT only)	
RF Interference	No alarm 10 V/m	
Operation temperature	-20 – +60°C (-4 – +140°F)	
Environment humidity	95% max.	
Weatherproof	IP55	
Mounting	Wall (Outdoor, Indoor)	
Mounting height	0.8 – 1.2 m (2'7" – 3'11")	
Weight	180 g (6.4 oz.) without wireless transmitter and battery	
Accessories	screw (3 × 20 mm) × 2	

\*Specifications and design are subject to change without prior notice.

## 7-2 DIMENSIONS

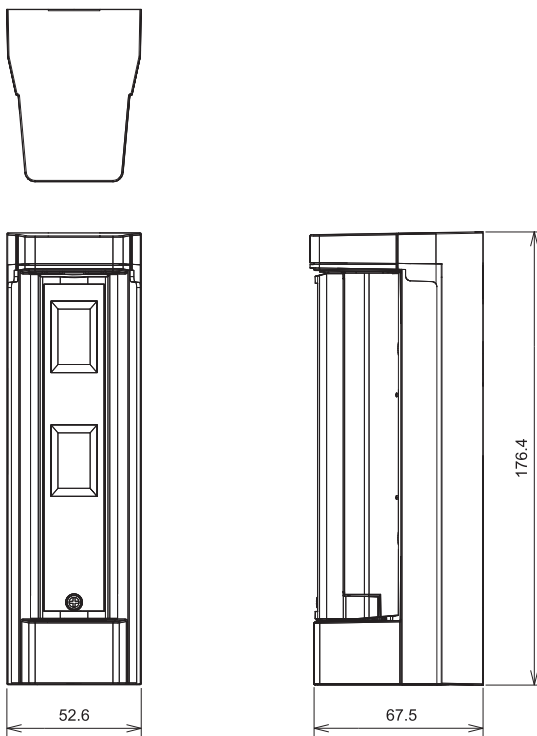

Unit: mm

### **Note>>**

- These units are designed to detect an intruder and activate an alarm control panel. Being only a part of a complete system, we cannot accept responsibility for any damages or other consequences resulting from an intrusion.



**OPTEX CO., LTD. (JAPAN)**

URL: <http://www.optex.net/>

**OPTEX INC. (U.S.)**

URL: <http://www.optexamerica.com/>

**OPTEX DO BRASIL LTDA. (Brazil)**

URL: <http://www.optex.net/br/es/sec/>

**OPTEX (EUROPE) LTD. / EMEA HQ (U.K.)**

URL: <http://www.optexeurope.com/>

**OPTEX TECHNOLOGIES B.V.  
(The Netherlands)**

URL: <http://www.optex.nl/>

**OPTEX SECURITY SAS (France)**

URL: <http://www.optex-security.com/>

**OPTEX SECURITY Sp.z o.o. (Poland)**

URL: <http://www.optex.com.pl/>

**OPTEX PINNACLE INDIA, PVT., LTD. (India)**

URL: <http://www.optex.net./in/en/sec/>

**OPTEX KOREA CO.,LTD. (Korea)**

URL: <http://www.optexkorea.com/>

**OPTEX (DONGGUAN) CO.,LTD.  
SHANGHAI OFFICE (China)**

URL: <http://www.optexchina.com/>