



RG-AP820-L(V3)

Wi-Fi 6 Dual-Radio
Settled Access Point

01

Product Overview

The RG-AP820-L(V3) is a dual-radio 802.11ax-compliant settled wireless access point (AP) provided by Ruijie Networks for general education, higher education, government, finance, business, and other indoor scenarios. Compared with the RG-AP820-L(V2), the RG-AP820-L(V3) adds the optical port.

It complies with 802.11ax, 802.11ac Wave 2, 802.11ac Wave 1, and 802.11n. With a hardware-independent dual-radio design, the RG-AP820-L(V3) can provide a data rate of up to 2.976 Gbps. The ultra-fast wireless rate eliminates the performance bottleneck.

The design of the RG-AP820-L(V3) considers factors

such as wireless network security, radio control, mobile access, QoS, seamless roaming, and Internet of Things (IoT) scalability. With Ruijie's wireless access controller (AC), the RG-AP820-L(V3) can implement wireless client data forwarding, security features, access control, and IoT application extension.

The RG-AP820-L(V3) supports the local power supply and Power over Ethernet (PoE), which can be flexibly selected based on the onsite environment. It can be mounted against a wall or ceiling, simplifying deployment. This makes it suitable for large campuses, conference centers, plazas, enterprise offices, operating hotspots, and other similar scenarios.

02

Product Appearance



03

Product Highlights

- Maximum ROI (lifetime-free cloud management)
- HE160 support for higher throughput with latest Wi-Fi 6 chipsets
- Hybrid management (cloud/controller/standalone)
- Multiple WPA3 authentication and encryption modes including WPA3-Personal (SAE), WPA3-Personal mixed mode, WPA3-Enterprise (CCMP, 128 bits), improving data security
- Fit mode: IEEE 802.11k/v/r support, roaming stickiness optimization, and remote association improvement for better user experience
- OFDMA and 1024-QAM, improving multi-user efficiency
- Bluetooth 5.1 and iBeacon support

04

Product Features

Multiple Service Ports

The RG-AP820-L(V3) supports the wired rate of up to 2.5 Gbps.

One auto-negotiation Ethernet electrical port provides up to 1 Gbps wired access to implement high-speed transmission and conversion between wireless and wired networks.

One 2.5GE SFP port can adapt to different link types of a wired network and transmit data.

High-speed Wireless Access for Better Experience

The RG-AP820-L(V3) optimizes user experience by maximizing Wi-Fi utilization and substantially reducing airtime competition between clients. It provides Orthogonal Frequency-Division Multiple Access (OFDMA) and Multi-User Multiple-Input Multiple-Output (MU-MIMO). With up to 4 spatial streams (4SS) and 160 MHz channel bandwidth (HE160), the RG-AP820-L(V3) provides pioneering wireless capabilities for enterprises.

1024-QAM High-speed Access

The RG-AP820-L(V3) adopts the dual-radio design and complies with Wi-Fi standard IEEE 802.11ax. When dual radios are enabled, it can provide a wireless data rate of up to 2.975 Gbps to realize high-speed access experience.

OFDMA High-density User Access

OFDMA in IEEE 802.11ax enables the RG-AP820-L(V3) to divide a WLAN channel into multiple narrower sub-channels, with each user occupying one or more sub-channels. The RG-AP820-L(V3) can schedule services of multiple users, and receive and send packets concurrently. This reduces contention for air interface resources and backoff, shortens the network latency, and improves the network efficiency.

Seamless Switching

The RG-AP820-L(V3) supports Hotspot 2.0 of Wi-Fi Association (WFA) and automatic identity recognition, providing clients with seamless cellular-to-Wi-Fi switching.

Diverse Wi-Fi Technologies

It supports RF transmission technologies:

- Dynamic frequency selection (DFS) optimizes the use of available RF spectrum to prevent radar channel interference.
- Cyclic delay/shift diversity (CDD/CSD) improves downlink RF performance, and converts spatial diversity to frequency diversity to avoid intersymbol interference, thus reducing bit error rate (BER) and effectively reducing signal distortion.
- Maximum ratio combining (MRC) improves the signal quality at the receiving end and enhances reliability and performance of received signals.

It supports RF channel coding technologies:

- Space-time block coding (STBC) increases the range and improves signal receiving, and enhances reliability of data transmission.
- Low-density parity check (LDPC) corrects errors efficiently and improves the throughput.
- Transmit beam-forming (TxBF) expands the signal coverage and enhances the reliability of specific devices, thereby improving the data rate.

Intelligent Optimization, Reliability Guarantee

Intelligent Recognition

The RG-AP820-L(V3) can intelligently identify mobile clients such as iOS and Android clients and PCs. It can be used to implement visualized wireless network management based on the wireless client type and optimize a network in one-click mode. The RG-AP820-L(V3) embeds client experience measurement and environment collection capability. It can be used with the RG-WS wireless access controller for intelligent analysis and automatic RF resource scheduling. It can adjust the RF power and intelligently allocate channels to solve problems such as co-channel interference, adjacent channel interference, and roaming stickiness.

Intelligent Local Forwarding

The RG-AP820-L(V3) integrates intelligent local forwarding technology to eliminate the traffic bottleneck on its connected wireless access controller. The data forwarding mode of the RG-

AP820-L(V3) can be flexibly pre-configured through Ruijie's wireless access controller. Then the RG-AP820-L(V3) determines whether data needs to be forwarded by the wireless access controller or be sent to a wired network for data exchange based on the SSID or user VLAN.

With the local forwarding technology, the RG-AP820-L(V3) classifies the data that is sensitive to the delay and requires real-time high-performance transmission, and forwards it through a wired network. This greatly relieves the traffic burden of the wireless access controller and better adapts to heavy-traffic transmission on 802.11ax networks.

Client Access Optimization

The RG-AP820-L(V3) can dynamically measure parameters such as the uplink Received Signal Strength Indicator (RSSI), noise floor, and channel utilization to intelligently identify the client network status. Moreover, it can steer clients to preferentially connect to 5 GHz or APs with better experience. This solves the problems of roaming stickiness, remote association, and load imbalance, and improves user experience.

Advanced Network Coexistence

The RG-AP820-L(V3) supports advanced network coexistence. It uses the built-in filter to automatically minimize the impact of interference from non-Wi-Fi network devices.

Abundant QoS Policies

The RG-AP820-L(V3) provides abundant QoS policies. It supports bandwidth limiting based on the WLAN, AP, and STA, and provides Wi-Fi Multimedia (WMM) that defines priorities for different service data. Therefore, it implements immediate and quantitative transmission of audio and video data, and guarantees smooth application of multimedia services.

The multicast-to-unicast technology supported by the RG-AP820-L(V3) solves the video freezing problem caused by packet loss or long latency in Video on Demand (VoD) and other multicast applications on a wireless network. It enhances the experience in the use of multicast video services on a wireless network.

Intelligent Monitoring, Green Design, and Power Saving

Intelligent Power Monitoring

The RG-AP820-L(V3) can monitor the PoE output power and disable or enable some functions

according to the available power to ensure its normal operation.

- When powered by 802.3at, the RG-AP820-L(V3) starts up normally, but its downlink port and USB port cannot provide power for external devices.
- When powered by 802.3af, the RG-AP820-L(V3) starts up normally. Both RF cards can only work in one-stream mode, and the downlink port and USB port cannot provide power for external devices.

Energy Saving and Lower Power Consumption

The RG-AP820-L(V3) incorporates packet-based power control technology. With high-performance power design, the RG-AP820-L(V3) is energy-efficient while providing high-speed wireless access services.

Comprehensive Security Protection and Ease of Use

Comprehensive Wireless Security Protection

The RG-AP820-L(V3) supports WEP (64/128 bits), WPA-TKIP, WPA-PSK, WPA2-AES, WPA3 authentication and encryption methods, and PPSK and WPA3-OWE mixed mode. Only the AC is needed to provide security for user data without the need for an authentication server.

It supports the following WPA3 types: WPA3-Personal (SAE), WPA3-Personal mixed mode, WPA3-Enterprise (CCMP, 128 bits), WPA3-Enterprise (GCMP, 192 bits), WPA3-Enterprise mixed mode, WPA3-OWE, and WPA3-OWE mixed mode.

The RG-AP820-L(V3) used with the RG-WS series wireless access controller can provide a series of wireless security protection functions such as Wireless Intrusion Detection System (WIDS), radio interference tracking, rogue AP containment, anti-ARP spoofing, and DHCP protection, to build a secure and reliable wireless network.

Multiple Easy-to-Use Authentication Modes

The RG-AP820-L(V3) supports various authentication and encryption technologies, including web, 802.1X, WEP (64/128 bits), WPA-TKIP, WPA-PSK, WPA2-AES, WPA3, PPSK, WPA3-OWE mixed mode, WPA3-OWE, WPA3-OWE mixed mode, WPA3-OWE mixed mode, user accounts, and social authentication (required for Ruijie Cloud).

- The WPA2 device key is managed by eUPSK configured on an external server. When the device or device type changes, no additional configuration is required.

- It supports the following WPA3 types: WPA3-Personal (SAE), WPA3-Personal mixed mode, and WPA3-Enterprise (CCMP, 128 bits).

In compliance with standard Network Access Control (NAC), it offers control policies by authentication, authorization, device compliance check, and network attack detection or prevention. All these features guarantee high network security for authenticated users.

PPSK

The traditional Pre-shared Key (PSK) shared by all clients on a WLAN has a high probability of PSK leakage risks. Ruijie Personal PSK (PPSK) is an easy wireless authentication method with high security. Credentials can be created and revoked individually. Each PPSK can also be bound to a unique user or device.

PPSK brings the following benefits:

- High security by providing different passwords for each client and device for the same SSID
- Simple deployment with batch account creation
- Ease of use, offering the same experience as WPA or WPA2-PSK
- Out-of-box feature for the wireless access controller and Ruijie Cloud service
- No additional AAA server required

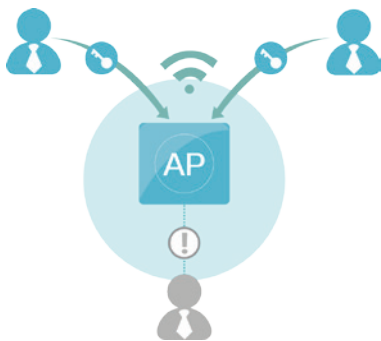

Simple and Effective Wireless Security Practice

Flexible Device Management Modes

Flexible Switching Between Fat, Fit, and Cloud Modes

The RG-AP820-L(V3) supports flexible switchover among Fat, Fit, and cloud deployment modes.

When the RG-AP820-L(V3) is deployed in Fat and cloud mode, it can operate as a single device and be managed by the local access controller (AC). It can also be connected to the Ruijie public cloud for cloud-based management. When the RG-AP820-L(V3) is deployed in Fit mode, it can be used with the AC to achieve more functions. In Fit mode, the RG-AP820-L(V3) can be deployed through Zero Touch Provisioning (ZTP). In addition, complete remote management also greatly enhances the O&M management efficiency of a wireless network.

Web Management

The RG-AP820-L(V3) provides the web management GUI of the AP and AC, on which O&M personnel can complete wireless configuration easily and manage the wireless network in an all-round manner. On the AC web GUI, O&M personnel can manage the AP as well as clients connected to the AP, and rate-limit clients and restrict network access behaviors of clients. With the GUI, O&M personnel can plan, manage, and maintain wireless networks conveniently.

Mobile Monitoring and Optimization

You can use the free Ruijie Cloud App to achieve simple network management experience. This app features unified device lifecycle management, switches, and security gateways. The app also simplifies device provisioning, monitoring, configuration, and optimization. For details, visit official website at <https://www.ruijienetworks.com/products/smb/cloud-service/cloud-service/ruijie-cloud-solution/mobile-app>.

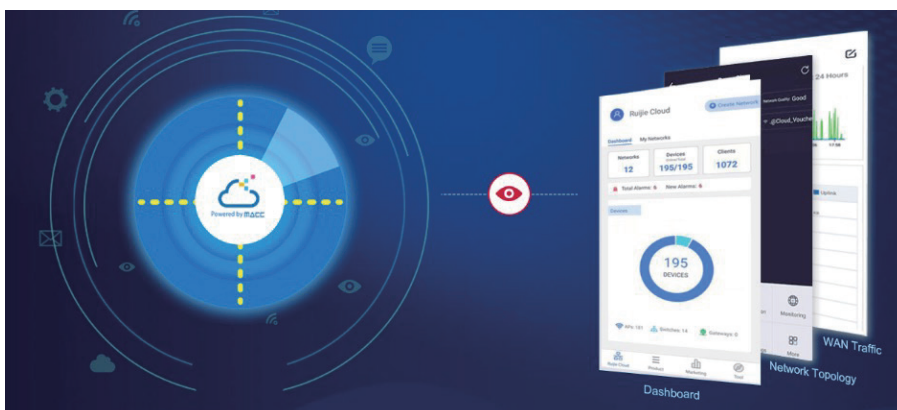

All-in-One for Small Branch Office

In small branch office scenarios, the RG-AP820-L(V3) serves as an AP to provide the wireless access service for the office area, and also functions as a VPN gateway. This all-in-one design simplifies network deployment and saves building costs.

PPPoE

The RG-AP820-L(V3) can function as a PPPoE client and connects to the Internet through PPPoE. In this case, no gateway needs to be deployed in a branch

office area for Internet access.

NAT

The RG-AP820-L(V3) supports the Network Address Translation (NAT) function to translate addresses between the LAN in the branch office and the Internet.

IPsec VPN

The RG-AP820-L(V3) can establish IPsec VPN tunnels between the headquarters and branch offices to implement LAN interconnection.

05

Specifications

Hardware Specifications

Dimensions and Weight

Dimensions and Weight	RG-AP820-L(V3)
Unit dimensions (W x D x H)	220 mm x 220 mm x 49 mm (8.66 in x 8.66 in x 1.93 in)
Shipping dimensions (W x D x H)	507 mm x 319 mm x 278 mm (19.96 in x 12.56 in x 10.94 in)
Unit weight	Main unit: 0.6 kg (1.33 lbs) Mounting bracket: 0.07 kg (0.15 lbs)
Shipping weight	1.04 kg (2.29 lbs)
Mounting	Wall/Ceiling-mount (a mounting bracket is delivered with the main unit)
Lock option	Kensington lock and securing latch

Wi-Fi Radio

Wi-Fi Radio	RG-AP820-L(V3)
Radio design	Dual-radio and up to four spatial streams: <ul style="list-style-type: none"> Radio 1: 2.4 GHz, two spatial streams, 2x2 MU-MIMO Radio 2: 5 GHz, two spatial streams, 2x2 MU-MIMO
Operating frequencies	Radio 1, 802.11b/g/n/ax: <ul style="list-style-type: none"> 2.400 GHz to 2.4835 GHz, ISM Radio 2, 802.11a/n/ac/ax: <ul style="list-style-type: none"> 5.150 GHz to 5.250 GHz, U-NII-1 5.250 GHz to 5.350 GHz, U-NII-2A 5.470 GHz to 5.725 GHz, U-NII-2C 5.725 GHz to 5.850 GHz, U-NII-3/ISM Note: Country-specific restrictions apply.

Wi-Fi Radio	RG-AP820-L(V3)
Data rates	Combined peak data rate: 2.976 Gbps 2.4 GHz radio <ul style="list-style-type: none"> • Two spatial stream Single User (SU) MIMO for up to 574 Mbps wireless data rate to individual 2SS HE40 802.11ax client devices (max.) • Two spatial stream Single User (SU) MIMO for up to 287 Mbps wireless data rate to individual 2SS HE20 802.11ax client devices (typical) 5 GHz radio <ul style="list-style-type: none"> • Two spatial stream Single User (SU) MIMO for up to 2.402 Gbps wireless data rate to individual 2SS HE160 802.11ax client devices (max.) • Two spatial stream Single User (SU) MIMO for up to 1.201 Gbps wireless data rate to individual 2SS HE80 802.11ax client devices (typical)
Data rate set	The following 802.11-compliant data rates in Mbps are supported: 2.4 GHz radio <ul style="list-style-type: none"> • 802.11b: 1, 2, 5.5, 11 • 802.11g: 1, 2, 5.5, 6, 9, 11, 12, 18, 24, 36, 48, 54 • 802.11n: 6.5 to 300 (MCS0 to MCS15, HT20 to HT40) • 802.11ax: 8.6 to 574 (MCS0 to MCS11, NSS = 1 to 2, HE20 to HE40) 5 GHz radio <ul style="list-style-type: none"> • 802.11a: 6, 9, 12, 18, 24, 36, 48, 54 • 802.11n: 6.5 to 300 (MCS0 to MCS15, HT20 to HT40) • 802.11ac: 6.5 to 1,732 (MCS0 to MCS9, NSS = 1 to 4, VHT20 to VHT160) • 802.11ax: 8.6 to 2,402 (MCS0 to MCS11, NSS = 1 to 2, HE20 to HE160)
Packet aggregation	802.11n/ac/ax: A-MPDU and A-MSDU
Antenna type	Built-in omnidirectional antenna (two 2.4 GHz antennas and two 5 GHz antennas)
Max. antenna gain	2.8 dBi in 2.4 GHz and 3.6 dBi in 5 GHz The downtilt angle for the maximum gain is roughly 30 degrees. With reference to the pattern of each antenna of the MIMO radios, the maximum gain of the effective per-antenna pattern is 2.3 dBi in the 2.4 GHz radio and 2.7 dBi in the 5 GHz radio.
Max. transmit power	2.4 GHz radio: 26 dBm (23 dBm per chain) 5 GHz radio: 26 dBm (23 dBm per chain) Note: The transmit power is limited by local regulatory requirements.
Power increment	Configurable in increments of 1 dBm
Radio technologies	802.11b: Direct-Sequence Spread-Spectrum (DSSS) 802.11a/g/n/ac: Orthogonal Frequency-Division Multiplexing (OFDM) 802.11ax: Orthogonal Frequency Division Multiple Access (OFDMA)
Modulation types	802.11b: BPSK, QPSK, CCK 802.11a/g/n: BPSK, QPSK, 16-QAM, 64-QAM 802.11ac: BPSK, QPSK, 16-QAM, 64-QAM, 256-QAM 802.11ax: BPSK, QPSK, 16-QAM, 64-QAM, 256-QAM, 1024-QAM

The following table lists the radio frequency performance of Wi-Fi including different frequency bands, protocols, and data rates. It is country-specific, and Ruijie Networks reserves the right of interpretation.

Wi-Fi Radio Frequency Performance	RG-AP820-L(V3)		
Frequency Band and Protocol	Data Rate	Max. Transmit Power per Transmit Chain	Max. Receive Sensitivity per Receive Chain
2.4 GHz 802.11b	1 Mbps	23 dBm	-91 dBm
	2 Mbps	23 dBm	-91 dBm
	5.5 Mbps	23 dBm	-90 dBm
	11 Mbps	23 dBm	-87 dBm

Wi-Fi Radio Frequency Performance		RG-AP820-L(V3)	
Frequency Band and Protocol	Data Rate	Max. Transmit Power per Transmit Chain	Max. Receive Sensitivity per Receive Chain
2.4 GHz 802.11g	6 Mbps	23 dBm	-89 dBm
	24 Mbps	22 dBm	-82 dBm
	36 Mbps	22 dBm	-78 dBm
	54 Mbps	20 dBm	-72 dBm
2.4 GHz 802.11n (HT20)	MCS0	23 dBm	-85dBm
	MCS7	19 dBm	-67 dBm
2.4 GHz 802.11n (HT40)	MCS0	23 dBm	-82 dBm
	MCS7	19 dBm	-64 dBm
2.4 GHz 802.11ax (HE20)	MCS0	23 dBm	-85 dBm
	MCS11	15 dBm	-58 dBm
2.4 GHz 802.11ax (HE40)	MCS0	23 dBm	-82 dBm
	MCS11	15 dBm	-54 dBm
5 GHz 802.11a	6 Mbps	23 dBm	-89 dBm
	24 Mbps	22 dBm	-82 dBm
	36 Mbps	22 dBm	-78 dBm
	54 Mbps	20 dBm	-72 dBm
5 GHz 802.11n (HT20)	MCS0	23 dBm	-85 dBm
	MCS7	19 dBm	-67 dBm
5 GHz 802.11n (HT40)	MCS0	23 dBm	-82 dBm
	MCS7	19 dBm	-64 dBm
5 GHz 802.11ac (VHT20)	MCS0	23 dBm	-85 dBm
	MCS9	18 dBm	-60 dBm
5 GHz 802.11ac (VHT40)	MCS0	23 dBm	-82 dBm
	MCS9	18 dBm	-57 dBm
5 GHz 802.11ac (VHT80)	MCS0	23 dBm	-79 dBm
	MCS9	18 dBm	-53 dBm
5 GHz 802.11ax (HE20)	MCS0	23 dBm	-85 dBm
	MCS11	16 dBm	-58 dBm
5 GHz 802.11ax (HE40)	MCS0	23 dBm	-82 dBm
	MCS11	16 dBm	-54 dBm
5 GHz 802.11ax (HE80)	MCS0	23 dBm	-79 dBm
	MCS11	16 dBm	-52 dBm
5 GHz 802.11ax (HE160)	MCS0	23 dBm	-77 dBm
	MCS11	16 dBm	-50 dBm

Bluetooth Radio

Bluetooth Radio	RG-AP820-L(V3)
Bluetooth	Bluetooth 5.1
Antenna type	Onboard omnidirectional antenna
Max. antenna gain	2.4 dBi, with a downtilt angle of roughly 30 degrees
Max. transmit power	17 dBm (GFSK) 14 dBm ($\pi/4$ -DQPSK, 8-DPSK)
Receive sensitivity	-95.5 dBm (DH5) -95 dBm ($\pi/4$ -DQPSK) -87.5 dBm (8-DPSK)

Ports

Ports	RG-AP820-L(V3)
Fixed service port	1 x 10/100/1000Base-T RJ45 Ethernet port with auto-negotiation <ul style="list-style-type: none"> • Compliance with IEEE 802.3af standard (PoE) • Auto MDI/MDIX crossover • PoE-PD: 54 V DC (nominal) 802.3af/at/bt (Class 3 or higher) • 802.3az EEE 1 x 2.5GE SFP combo port conformity to 1GE
Fixed management port	1 x RJ45 console port (serial console port)
Status LED	1 x multi-color system status LED
Button	1 x Reset button <ul style="list-style-type: none"> • Press the button for shorter than 2 seconds. Then the device restarts. • Press the button for longer than 5 seconds. Then the device restores to factory settings.

Power Supply and Consumption

Power Supply and Consumption	RG-AP820-L(V3)
Input power supply	The AP supports the following two power supply modes: <ul style="list-style-type: none"> • 48 V DC/0.6 A power input over DC connector: The DC connector accepts 2.1 mm/5.5 mm center-positive circular plug. A DC power adapter needs to be purchased separately. • PoE input over LAN 1: The power source equipment (PSE) complies with IEEE 802.3af standard (PoE). Note: <ul style="list-style-type: none"> • If both DC power and PoE are available, DC power is preferred.
Power consumption	Max power consumption: 12.95 W <ul style="list-style-type: none"> • DC powered: 12.95 W • PoE powered (802.3af): 12.95 W • PoE+ powered (802.3at): 12.95 W • PoE++ powered (802.3bt): 12.95 W • Idle mode: 6 W

Environment and Reliability

Environment and Reliability	RG-AP820-L(V3)
Temperature	Operating temperature: -10°C to +50°C (14°F to +122°F) Storage temperature: -40°C to +70°C (-40°F to +158°F) Note: At an altitude between 3,000 m (9,843 ft) and 5,000 m (16,404 ft), every time the altitude increases by 220 m (722 ft), the maximum temperature decreases by 1°C (1.8°F).

Environment and Reliability	RG-AP820-L(V3)
Humidity	Operating humidity: 0% to 95% RH (non-condensing) Storage humidity: 0% to 95% RH (non-condensing)
Environment standard	Storage and operating environment: NEBS GR-63-CORE_Issue3_2006 GB/T 2423.6-1995
Mean Time Between Failure (MTBF)	200,000 hours (22 years) at the operating temperature of 25°C (77°F)
Security regulations	GB 4943.1, IEC 62368-1
EMC regulations	EN 300386, GB/T 19286, GB/T 17618 FCC Part 15
Radio frequency regulations	FCC Part 15E: 15.407

Regulatory Compliance

Regulatory Compliance	RG-AP820-L(V3)
Regulatory compliance	EN 55032 EN 55035 EN 61000-3-3 EN IEC 61000-3-2 EN 301 489-1 EN 301 489-3 EN 301 489-17 EN 300 328 EN 301 893 EN 300 440 FCC Part 15 EN IEC 62311 IEC 62368-1 EN 62368-1

*For more country-specific regulatory information and approvals, contact your local sales agency.

Software Specifications

Applicable Software Version	RG-AP820-L(V3)
Applicable software version	RGOS11.9(6)W1B4 or higher

WLAN

WLAN	RG-AP820-L(V3)
Max. number of BSSIDs	32 (up to 16 BSSIDs per radio)
STA management	SSID hiding Each SSID can be configured with the authentication mode, encryption mechanism, and VLAN attributes independently. Remote intelligent perception technology (RIPT) Intelligent client identification technology Intelligent load balancing based on the STA quantity or traffic
STA limiting	SSID-based STA limiting Radio-based STA limiting
Bandwidth limiting	STA/SSID/AP-based rate limiting
Wireless roaming	Layer 2 and Layer 3 roaming

Security

Security	RG-AP820-L(V3)
Authentication and encryption	Remote Authentication Dial-In User Service (RADIUS) PSK and web authentication QR code-based guest authentication, SMS authentication, MAB authentication (used with the RG-WS series wireless access controller) Data encryption: WPA-TKIP, WPA-PSK, WPA2-AES, WEP (64/128-bit)
Data frame filtering	Allowlist, static blocklist, and dynamic blocklist
WIDS	User isolation Rogue AP detection and containment
ACL	Dynamic ACL assignment
CPP	Supported
NFPP	Supported

Routing and Switching

Routing and Switching	RG-AP820-L(V3)
IP service	Static IPv4 address IPv4 DHCP Client FTP ALG and DNS ALG
Multicast	Multicast-to-unicast conversion
IPv6 basics	IPv6 addressing, Neighbor Discovery (ND), ICMPv6, IPv6 Ping IPv6 DHCP Client
IP routing	IPv4/IPv6 static routing
VPN	PPPoE Client IPsec VPN

Management

Management	RG-AP820-L(V3)
Network management	SNMPv1/v2c/v3 Fault inspection and alarm Information statistics and logging
Network management platform	Ruijie Cloud Web-based management (Eweb)
User access management	Telnet, SSH, and TFTP-based management
Fat/Fit/Cloud mode switchover	When the AP works in Fit mode, it can be switched to Fat mode through an AC. When the AP works in Fat mode, it can be switched to Fit mode through the console port or Telnet. When the AP works in Cloud mode, it can be managed through Ruijie Cloud.

06

Antenna Pattern Plots

Horizontal Planes (Top View)

The following figures show the azimuth antenna pattern at 2.4 GHz and 5 GHz radios.

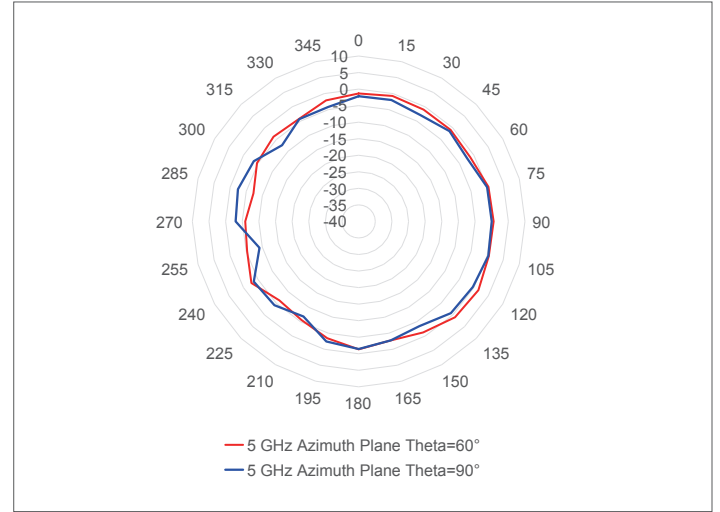
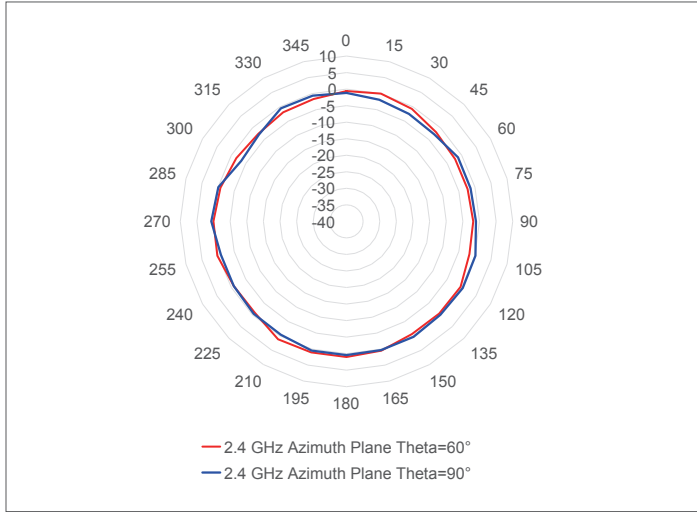

Vertical Planes (Side View, AP Facing Down)

The following figures show the evaluation antenna pattern at 2.4 GHz and 5 GHz radios.

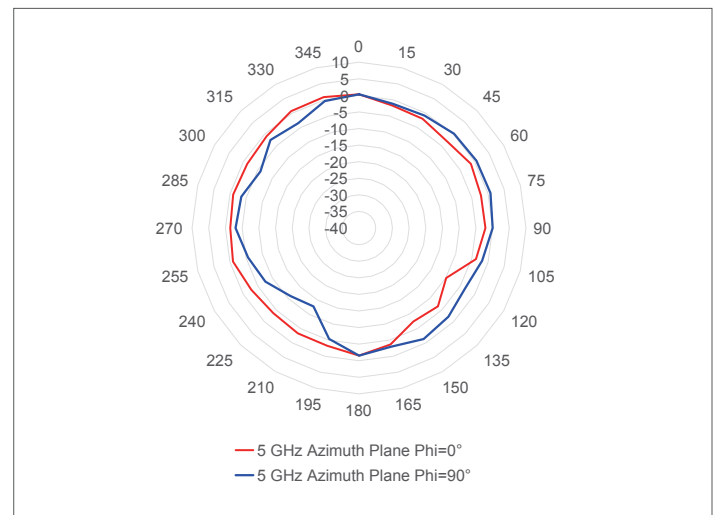
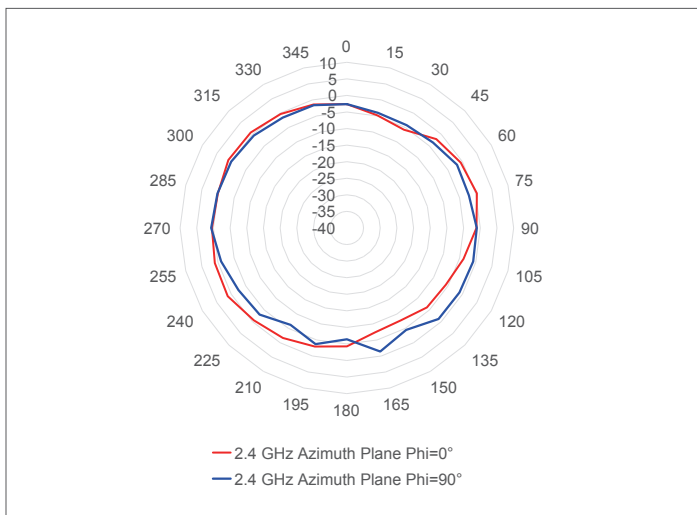

Note: Operating frequency bands are country-specific.

07

Typical Applications

Typical Scenario

The AP is applicable to densely populated areas with simple building structures, no special obstructions, and a large

capacity demand. Such areas cover the scenarios of meeting rooms, libraries, classrooms, bars, and leisure centers. The AP can be flexibly deployed based on the environment.

The following figure shows the typical network topology of the RG-AP820-L(V3).

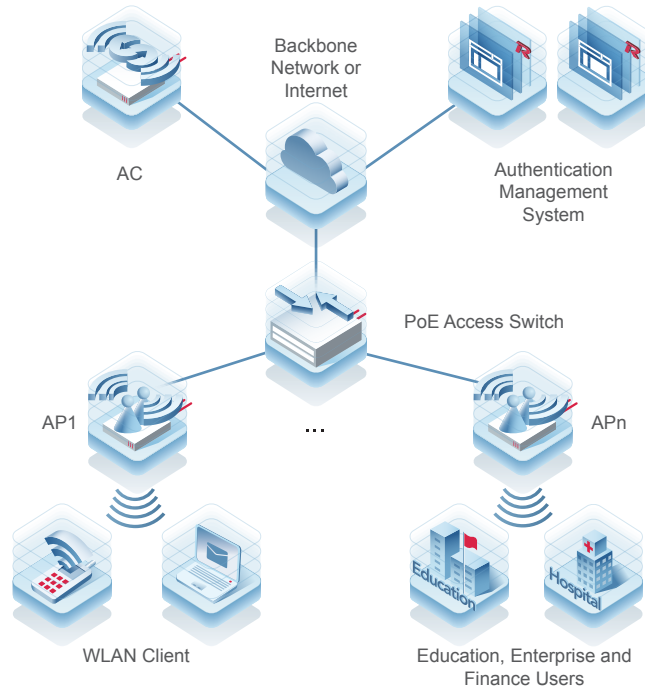

Public Cloud Deployment

With Ruijie public cloud service, the RG-AP820-L(V3) is fit for SME scenarios, including small offices, boutique hotels, and retail stores. Ruijie Networks provides customers with Ruijie Cloud lifetime free licenses. It significantly streamlines the IT operational efficiency, and simplifies wireless deployment with cost-effective options for SMEs.

The Ruijie Cloud service provides network provisioning, monitoring, optimization, operation, and maintenance. Devices can be easily deployed or swapped in plug-and-play mode. Automatic RF planning meets the needs of increasing user experience.

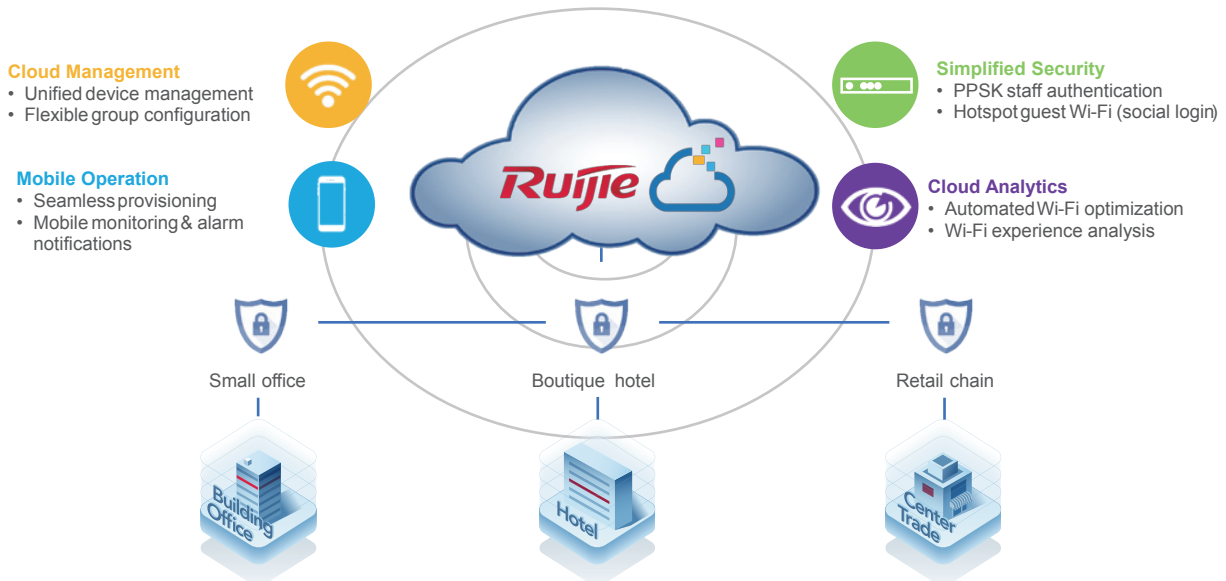

Key Features:

- Unified device management
- Fast provisioning by Cloud and App
- Secure PPSK/UPSK authentication
- Captive portal & social media authentication
- App-based monitoring and alarm

Hybrid Cloud Deployment

For enterprise office, campus network, and hospitality customers with single or multiple sites, a hybrid mode consisting of Ruijie RG-WS series wireless access controller (on-premises) and cloud-based management (optional) is recommended for high-density AP deployment. Wireless access controllers are installed at the customer's site with fully integrated wireless management and authentication features, supporting large-scale AP management with cluster-based controller architecture. Optionally, the cloud management platform allows for value-added features such as centralized device configuration and monitoring, and reporting.

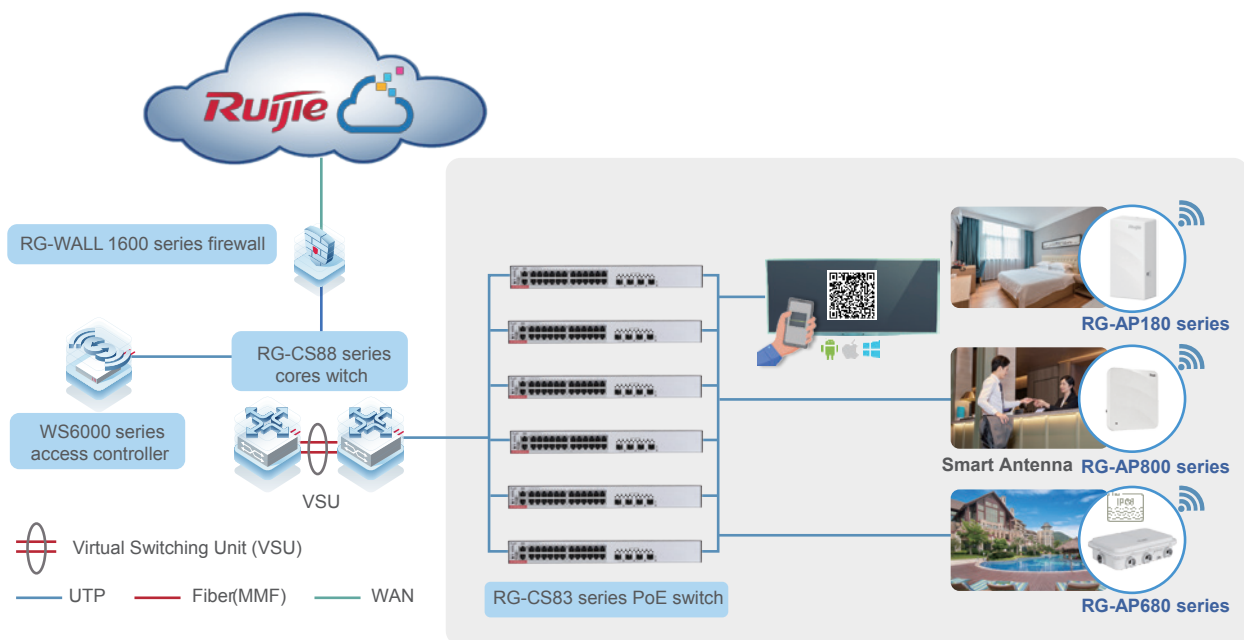

Key Features:

- Centralized device management and reporting by Ruijie Cloud
- Ultra-seamless roaming management
- High performance and security with all user authentication and traffic forwarding handled locally
- Flexible authentication options, including 802.1X, PPSK/UPSK, and voucher authentication
- Unified management of all series of Ruijie APs

08

Ordering Information

Model	Description
RG-AP820-L(V3)	Wi-Fi 6 dual-radio indoor wireless access point Up to four spatial streams Data rate of up to 2.976 Gbps Compliance with IEEE 802.11a/b/g/n/ac and 802.11ax standards Fat/Fit/Cloud mode switchover IEEE 802.3af-compliant (PoE) power supply and DC power supply
RG-E-120(GE)	PSE with 1 x GE port in compliance with IEEE 802.3af standard (PoE)

09

Package Contents

Item	Quantity
Main unit	1
Mounting bracket	1
Wall anchor	2
Cross recessed pan head self-tapping screw	4
Warranty Card and Hazardous Substance Table	1
Quick Start Guide	1

10

Warranty

For more information about warranty terms and period, contact your local sales agency:

- Warranty terms: <https://www.ruijienetworks.com/support/servicepolicy>
- Warranty period: <https://www.ruijienetworks.com/support/servicepolicy/Service-Support-Summary>

Note: The warranty terms are subject to the terms of different countries and distributors.

11

More Information

For more information about Ruijie Networks, visit the official Ruijie website or contact your local sales agency:

- Ruijie Networks official website: <https://www.ruijienetworks.com/>
- Online support: <https://www.ruijienetworks.com/support>
- Hotline support: <https://www.ruijienetworks.com/support/hotline>
- Email support: service_rj@ruijienetworks.com



Copyright ©2000-2023 Ruijie Networks Co., Ltd. All rights reserved.

No part of this document may be reproduced or transmitted in any form or any means without prior written consent of Ruijie Networks Co., Ltd.

Notice

This content is applicable only to regions outside the China mainland. Ruijie Networks Co., Ltd. reserves the right to interpret this content.

The information contained herein is subject to change without notice. Nothing herein should be construed as constituting an additional warranty. Ruijie Networks Co., Ltd. shall not be liable for technical or editorial errors or omissions contained herein.



Ruijie Networks Co., Ltd
Website: <https://www.ruijienetworks.com>